



LANDMARKS COMMISSION AGENDA

Wednesday, April 3, 2024
6:00 p.m.

This meeting includes in-person and virtual participation.

Council Chambers

333 Broadalbin Street SW

Or join the meeting here:

<https://council.cityofalbany.net/groups/lac/zoom>

You can use your microphone or dial in using your phone.

Call: +1 (253) 215-8782 (long distance charges may apply)

Meeting Id: 891-3470-9381 Passcode: 530561

Please help us get Albany's work done.

Be respectful and refer to the rules of conduct posted by the main door to the Chambers and on the website.

1. Call to Order and Pledge of Allegiance
2. Roll Call
3. Approval of Minutes

- March 6, 2024 [Pages 3-4]

4. Business from the Public

Persons wanting to provide comments may:

1- *Email written comments to cdaa@albanyoregon.gov, including your name, before **noon on the day of the meeting.***

2- *To comment virtually during the meeting, register by emailing cdaa@albanyoregon.gov before **noon on the day of the meeting**, with your name. The chair will call upon those who have registered to speak.*

3- *Appear in person at the meeting and register to speak.*

5. Scheduled Business

- A. HI-02-24, Type III – Quasi-Judicial Process [Pages 5-26]

Summary: Historic Review of Exterior Alterations to add solar panels to a house located at 538 4th Avenue SW.

(Project planner – Alyssa Schrems alyssa.schrems@albanyoregon.gov)

albanyoregon.gov/cd



B. Historic Preservation Awards

6. Business from the Commission
7. Staff Updates
8. Next Meeting Date: Wednesday, May 1, 2024
9. Adjournment

This meeting is accessible to the public via video connection. The location for in-person attendance is accessible to people with disabilities. If you have a disability that requires accommodation, please notify city staff at least 48 hours in advance of the meeting at: cdaa@albanyoregon.gov or call 541-917-7550

Testimony provided at the meeting is part of the public record. Meetings are recorded, capturing both in-person and virtual participation, and are posted on the City website.



LANDMARKS COMMISSION

MINUTES

March 6, 2024

6:00 p.m.

Hybrid – Council Chambers

Approved: Draft

Call to Order

Commissioner Robinson called the meeting to order at 6:00 p.m.

Pledge of Allegiance

6:00 p.m.

Roll Call

Members present: Chad Robinson, Bill Ryals, Camron Settlemier, Mason Cox, Richard Engeman, Cathy Winterrowd, Rayne Legras (arrived 6:07 p.m.)

Members absent: None

Approval of February 7, 2024, Minutes

6:03 p.m.

Motion: Commissioner Winterrowd moved to approve the minutes from February 7, 2024. Commissioner Cox seconded the motion, which passed 6-0.

Business from the Public

6:03 p.m.

Marketing Manager, Kim Jackson, with the Albany Visitors Association offered to be a resource for the Historic Preservation Month events.

Albany Downtown Association, Executive Director, Lise Grato brought the Commission the current newsletter and reviewed the upcoming community events for March.

Scheduled Business

6:07 p.m.

Cumberland Church Updates

Planner II, Alyssa Schrems announced that the Cumberland Church has received the State's recommendation to the National Historic Register process for listing.

Final Draft Surveys

6:08 p.m.

Current Planning Manager, David Martineau, asked the Commission if they had any additional comments or questions regarding the surveys presented at the last meeting. There were no changes recommended.

Historic Preservation Award Nominations

6:09 p.m.

Schrems asked if there were any residential or commercial historic preservation renovations members wanted to nominate. Or individual nomination for someone dedicated to historic preservation.

Commissioner Ryals nominated an infill in Hackleman, 326 6th Avenue SE designed as a little craftsman bungalow, a new build and infill in the district.

Commissioner Settlemier had two nominations. The first was a multi-family home on the corner of Ferry and 3rd that had been heavily damaged by fire. The other is the Albany Fire Department for restoration of their 1935 Seagrave fire truck.

Commissioner Ryals asked if the 1st Hand Second store had been given an award. Schrems said work hadn't been completed last year. He supported nominating them. Commissioner Ryals suggested that nominating a building could include the owner, contractor and architect together as a team.

Schrems will put together a slide show of nominees for next month's meeting.

Planning for Historic Preservation Month

6:17 p.m.

March 6, 2024

Schrems began by sharing that she had gotten in touch with the Parks Department, and they are willing to run an interpretive walk on the historic apple orchard but during May, they will be doing pruning, and it may be better to wait until summer when the orchard looks better, and the weather will be better. She emphasized that parking will be an issue.

Schrems asked about the Window Preservation Workshop at the Cumberland Church and whether they would be interested in funding that. Commissioner Legras thought they should be using the money for what it was budgeted for. Commissioner Winterrowd asked if the workshop could just target Albany participants. Schrems added that any available funds for the Window Restoration Workshop, June may be too late, but there could be partial funding. They did budget for Historic Restoration activities and outreach; they should know the available amounts before the next meeting.

Commissioner Robinson asked about the interest in the pass-through grants. Schrems said the process is difficult for some, but they usually get two or three that do go through the process. Commissioners agreed about promoting the pass-through match grants. Martineau added it should be a competitive process with applications reviewed by the Commission. Staff proposed that outreach might include website postings, mailers in historic district (possibly including the survey), post in newsletter. Schrems shared that in the past the selection process was in June and once approved applications must go through the State Historic Preservation Office for plan approval.

Schrems reminded members about their suggestion to provide a talk on How to Research the History of Your Home activity. There was a proposal to do one during the Historic Preservation Month then after the home tours in the summer.

Schrems then shifted to the other suggestion to have an OSU professor (she could not remember the name) provide a lecture on tribal history of the area at the library. If the other professor is unavailable, she will reach out to David Lewis, PhD. Commissioner Winterrowd thought the library would be a great place to give a talk. She also suggested that there might be someone from the Park Service that might be able to give a lecture as well. Commissioner Robinson mentioned a photographer that worked on a project regarding the Oregon Trail of Tears and may be able do a corresponding lecture. Schrems will do follow up on the library availability.

Martineau reminded them about the Santiam Wagon Road and Park Service activity. Schrems clarified that the Forest Service is planning a Santiam Wagon Road celebration in late September which would incorporate reenactments and other activities around the Santiam Pass and interpretative signs at trailheads. She noted no one was scheduled for the display window for May, so that was another opportunity for ideas.

Business from the Commission

6:40 p.m.

None.

Next Meeting Date

The next regularly scheduled meeting is on Wednesday, April 3, 2024.

Adjournment

6:42 p.m.

Hearing no further business, Chair Robinson adjourned the meeting at 6:42 p.m.

Respectfully submitted,

Reviewed by,

Susan Muniz
Recorder

David Martineau
Planning Manager

**Documents discussed at the meeting that are not in the agenda packet are archived in the record. The documents are available by emailing cdaa@albanyoregon.gov.*



COMMUNITY DEVELOPMENT

333 Broadalbin Street SW, PO Box 490, Albany, Oregon 97321-0144 | BUILDING & PLANNING 541-917-7550

Staff Report

Historic Review of Exterior Alterations

HI-02-23

March 26, 2024

Summary

This staff report evaluates a Historic Review of Exterior Alterations for a residential structure on a developed lot within the Monteith National Register Historic District (Attachment A). The applicant proposes installing solar panels on the historic home.

Application Information

Review Body:	Landmarks Commission (Type III review)
Staff Report Prepared By:	Alyssa Schrems, Planner II
Property Owner:	Karen & Louis Hans
Applicant:	Benjamin Steffen
Address/Location:	538 4th Avenue SW, Albany, OR 97321
Map/Tax Lot:	Linn County Tax Assessor's Map No. 11S-04W-12AA; Tax Lot 05200
Zoning:	Hackleman Monteith (HM) District (Monteith National Register Historic District)
Total Land Area:	9,900 square feet
Existing Land Use:	Single Unit Residential
Neighborhood:	Central Albany
Surrounding Zoning:	North: DMU- Downtown Mixed Use East: HM- Hackleman Monteith, MUR- Mixed Use Residential South HM- Hackleman Monteith West HM- Hackleman Monteith
Surrounding Uses:	North: Residential, Single Unit & Middle Housing; Mixed Use Development (in progress) East: Residential, Single Unit; Laundromat South Residential, Single Unit West Residential, Single Unit
Prior History:	N/A

Notice Information

On March 13, 2024, a notice of public hearing was mailed to property owners within 100 feet of the subject property. On March 21, 2024, notice of public hearing was posted on the subject site. As of March 26, 2024, no public testimony has been received.

Analysis of Development Code Criteria

Historic Review of Exterior Alterations Generally (ADC 7.120)



Albany Development Code (ADC) review criteria for Historic Review of Exterior Alterations Generally (ADC 7.120) are addressed in this report for the proposed development. The criteria must be satisfied to grant approval for this application. Code criteria are written in **bold** followed by findings, conclusions, and conditions of approval where conditions are necessary to meet the review criteria.

Exterior Alteration Criteria (ADC 7.100-7.165)

Section 7.150 of the ADC, Article 7, establishes the following review criteria in **bold** for Historic Review of Exterior Alterations applications. For applications other than the use of substitute materials, the review body must find that one of the following criteria has been met in order to approve an alteration request.

1. **The proposed alteration will cause the structure to more closely approximate the historical character, appearance, or material composition of the original structure than the existing structure; OR**
2. **The proposed alteration is compatible with the historic characteristics of the area and with the existing structure in massing, size, scale, materials, and architectural features.**

ADC 7.150 further provides the review body will use the Secretary of the Interior's Standards for Rehabilitation as guidelines in determining whether the proposed alteration meets the review criteria.

Secretary of Interior's Standards for Rehabilitation – (ADC 7.160)

The following standards are to be applied to rehabilitation projects in a reasonable manner, taking into consideration economic and technical feasibility.

1. **A property shall be used for its historic purpose or be placed in a new use that requires minimal change to the defining characteristics of the building and its site and environment.**
2. **The historic character of a property shall be retained and preserved. The removal of historic material or alteration of features and spaces that characterize a property shall be avoided.**
3. **Each property shall be recognized as a physical record of its time, place, and use. Changes that create a false sense of historical development, such as adding conjectural features or architectural elements from other buildings, shall not be undertaken.**
4. **Most properties change over time; those changes that have acquired historic significance in their own right shall be retained and preserved.**
5. **Distinctive features, finishes, and construction techniques or examples of craftsmanship that characterize a historic property shall be preserved.**
6. **Deteriorated historic features shall be repaired rather than replaced. Where the severity of deterioration requires replacement of a distinctive feature, the new feature shall match the old in design, color, texture, and other visual qualities and, where possible, materials. Replacement of missing features shall be substantiated by documentary, physical, or pictorial evidence.**
7. **Chemical or physical treatments, such as sandblasting, that cause damage to historic material shall not be used. The surface cleaning of structures, if appropriate, shall be undertaken using the gentlest means possible.**
8. **Significant archeological resources affected by a project shall be protected and preserved. If such resources must be disturbed, mitigation measures shall be undertaken.**
9. **New additions, exterior alterations, or related new construction shall not destroy historic materials that characterize the property. The new work shall be differentiated from the old and shall be compatible with the massing, size, scale, and architectural features to protect the historic integrity of the property and its environment.**
10. **New additions and adjacent or related new construction shall be undertaken in such a manner that if removed in the future, the essential form and integrity of the historic property and its environment would be unimpaired.**

The analysis includes findings related to the Exterior Alterations review criteria in ADC 7.150, followed by the evaluation of the applicable Secretary of Interior Standards in ADC 7.160. Staff conclusions are presented after the findings.

Findings of Fact

- 1.1 Location and Historic Character of the Area. The subject property is located at 538 4th Avenue SW in the Hackleman Monteith (HM) zoning district within the Monteith National Register Historic District. The surrounding properties are in the HM zoning district, the Downtown Mixed Use (DMU) zoning district, and the Mixed Use Residential (MUR) zoning district. Surrounding properties are developed with single dwelling unit residences, triplexes, fourplexes, a laundromat, and a mixed-use development that is in progress.
- 1.2 Historic Rating. The subject building is rated as a Historic Contributing resource in the Monteith National Register Historic District.
- 1.3 History and Architectural Style. The nomination form lists the architectural style of the building as Vernacular/Queen Anne (Attachment B).
- 1.4 Prior Alterations. The porch steps and railing have been previously altered.
- 1.5 Proposed Exterior Alterations. The applicant proposes to install 21 roof mounted solar panels on the north, south, east, and west roof elevations, with the related service being located on the south side of the house near the existing main service panel (facing the alley).

The applicant states that the panels will be low-profile and provided with an installation packet as part of the application (Attachments C.3 and C.4). While the panels will be visible from the street, they will not affect the roofline. The solar panels will also be removable, non-permanent structures.

Based on the facts provided, the addition of solar panels will not change the historic character, appearance, or material composition of the existing structure. Based on these facts, criterion ADC 7.150(2) is met.
- 1.6 Building Use (ADC 7.160(1)). The building's original use was a single unit house. The building is still used as a dwelling and the applicant does not propose to change the use as part of this application.

Only minimal exterior alterations are needed in association with the proposed use, which is consistent with ADC 7.160(1).
- 1.7 Historic Character (ADC 7.160(2)). The house was constructed in 1889 in the Queen Anne/Vernacular style. Distinctive features of the house include a slanted oriel window with stained glass and stick work (Attachment B).

The applicant states that the panels and hardware for the solar panels will be removable and that no historic material will be removed. There will be no alteration of any features or spaces that characterize the property as historic. Based on these facts, criterion ADC 7.160(2) is met.
- 1.8 Historic Record & Changes (ADC 7.160(3) and (4)). The house is designed in the Queen Anne/Vernacular style. The applicant proposes installing solar panels onto the roof with removable hardware in order to generate energy. No conjectural features or architectural elements are proposed in addition to the solar panels. Based on these facts, criterion ADC 7.160(3) and (4) are met.
- 1.9 Distinctive Characteristics (ADC 7.160(5)). The applicant states that there will be no changes to any features, finishes, construction techniques, or examples of craftsmanship with the addition of the solar panels. No changes are proposed to the roof pitch. Based on these facts, criterion ADC 7.160(5) is met.
- 1.10 Deteriorated Features (ADC 7.160(6)). The applicant states that there are no existing deteriorated historic features. Since there are no deteriorated historic features and the applicant is proposing to add solar panels and not change any existing features, criterion ADC 7.160(6) is satisfied.
- 1.11 Use of Chemical or Physical Treatments (ADC 7.160(7)). The applicant does not propose any chemical or physical treatments in relation to the installation of the solar panels and further states that cleaning of solar panels only requires soap and water. Based on these facts, criterion ADC 7.160(7) is met.

- 1.12 Significant Archaeological Resources (ADC 7.160(8)). The applicant states there are no known archeological resources located at or near this site. Based on these facts, this criterion appears to be met.
- 1.13 Historic Materials (ADC 7.160(9)). The applicant states that the project will not destroy any historic materials or make any changes to the massing, size, scale, or architectural features of the property. The removable solar panels will be set parallel with the existing roof and will not affect the profile or roofline of the structure. Based on these facts, the criterion in ADC 7.160(9) is met.
- 1.14 New Additions (ADC 7.160(10)). The applicant states they are not proposing any new additions or adjacent or related new construction. Solar panels will be installed with removable hardware and can conceivably be returned to its original form if a future property owner desired to remove the solar panels. Based on these facts, the criterion in ADC 7.160(10) is met.

Conclusions

- 1.1 The proposed exterior alterations will be compatible with the historic characteristics of the area and with the existing structure in massing, size, scale, materials, and architectural features.
- 1.2 The proposed alteration is consistent with the Secretary of the Interior's Standards in ADC 7.160.

Overall Conclusions

This proposal seeks to complete exterior alterations to add solar panels to the south, east and west roof of the house.

Staff finds all applicable criteria are met for the exterior alterations.

Options and Recommendations

The Landmarks Commission has three options with respect to the subject application:

- Option 1: Approve the request as proposed;
- Option 2: Approve the request with conditions of approval;
- Option 3: Deny the request.

Based on the discussion above, staff recommends the Landmarks Commission pursue Option 2 and approve the Exterior Alteration request with conditions. If the Landmarks Commission accepts this recommendation, the following motion is suggested.

Motion

I move to approve the exterior alterations including conditions of approval as noted in the staff report for application planning file no. HI-02-24. This motion is based on the findings and conclusions in the March 26, 2024, staff report and findings in support of the application made by the Landmarks Commission during deliberations on this matter.

Conditions of Approval

- Condition 1 **Exterior Alterations** – The proposed exterior alterations shall be performed and completed as specified in the staff report and application as submitted. Deviations from these descriptions may require additional review.

Attachments

- A. Location Map
- B. Historic Resource Survey
- C. Applicant's Submittal:
 1. Historic Review of Exterior Alterations Form
 2. Findings of Fact
 3. Roof Layout
 4. Site Plan
 5. Racking Plan
 6. Inverter Specifications Sheet
 7. Solar Panel Specifications Sheet

Acronyms

ADC	Albany Development Code
DMU	Downtown Mixed Use
HM	Hackleman Monteith District
MUR	Mixed Use Residential

Architectural Terms (Dictionary of Architecture & Construction 2nd Edition)

Corbel out:	to build out one or more courses of brick or stone from the face of a wall, forming support for timbers.
Oriel:	A bay window corbeled out from the wall of an upper story.
Stick Work:	Jagged and angular elements that express exposed frame construction.

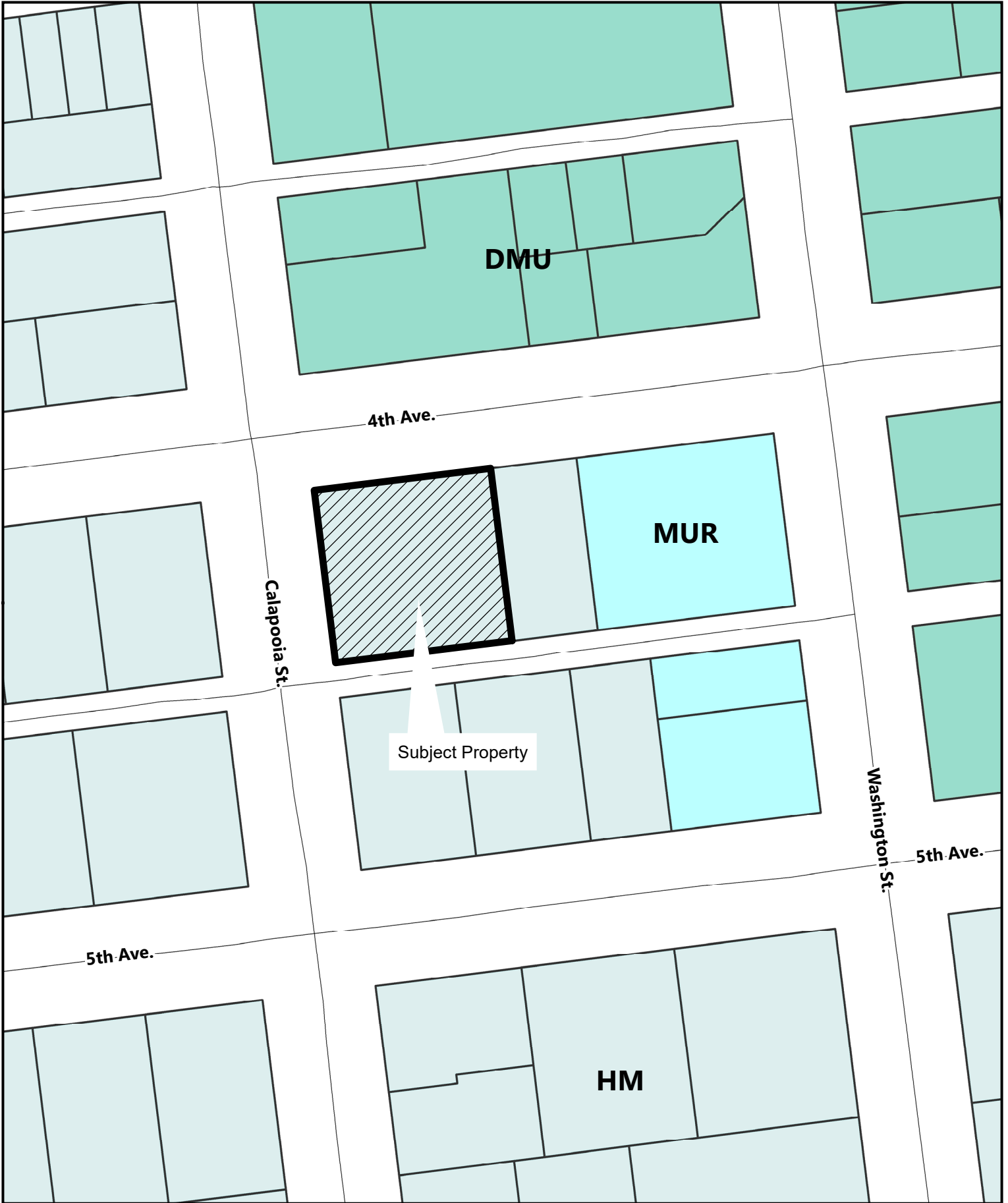

\\con.cityofalbany.net\home\analysis\GIS\Desktop\Notice Map Template.mxd

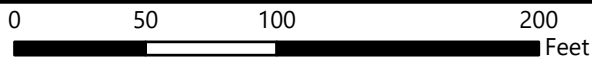

538 4th Ave SW

**OREGON INVENTORY OF HISTORIC PROPERTIES
HISTORIC RESOURCE SURVEY
ALBANY**

COUNTY : Linn

HISTORIC NAME : Thomas Monteith Jr. House	ORIGINAL USE : Residence
COMMON NAME :	CURRENT USE : Residence
ADDRESS : 538 4th Ave. SW	CONDITION : Good
CITY : Albany	INTEGRITY : Good MOVED : N
OWNER : Anne Shatrau	DATE OF CONSTRUCTION : 1889
CATAGORY : Building	THEME : 19th Century Architecture
LOCATION : Monteith Historic District	STYLE : Vernacular/Queen Anne
ASSOCIATED FEATURES : 0	ARCHITECT :
MAP NO : 11-4W-12AA TAX LOT : 05200	BUILDER :
BLOCK : 26 LOT : 1 & 2	QUADRANGLE : Albany
ADDITION NAME : Original Platt	LOCAL RANKING : Primary
PIN NO : 11S04W12AA05200 ZONING : HM	SPECIAL ASSESSMENT : N
PLAN TYPE/SHAPE : Irregular	NO. OF STORIES : 1
FOUNDATION MAT.: Concrete	BASEMENT : Y
ROOF FORM MAT. : Gable	PORCH : Hipped
STRUCTURAL FRAMING : Balloon	
PRIMARY WINDOW TYPE : 1/1 double hung	
EXTERIOR SURFACING MATERIALS: PRIMARY EXT : Drop siding	DECORATIVE : Shingle
DECORATIVE : Slanted oriel window with stained glass & stick work	
EXTERIOR ALTERATIONS/ADDITIONS : Porch steps and railing	
LANDSCAPE FEATURES : None	
OTHER : None	
RECORDED BY : Roz Keeney	DATE : 08/96
LOCAL INVENTORY NO. : M.021	SHPO INVENTORY NO. :
CASE FILE NO. :	



COMMUNITY DEVELOPMENT

333 Broadalbin Street SW, PO Box 490, Albany, Oregon 97321-0144 | BUILDING & PLANNING 541-917-7550

Historic Review of Exterior Alterations

Checklist and Review Criteria

INFORMATION AND INSTRUCTIONS:

- See fee schedule for filing fee (*subject to change every July 1*): staff will contact you for payment after submittal.
- All plans and drawings must be to scale, and review criteria responses should be provided as specified in this checklist.
- Email all materials to cd.customerservice@cityofalbany.net. Please call 541-917-7550 if you need assistance.
- Depending on the complexity of the project, paper copies of the application may be required.
- Before submitting your application, please check the following list to verify you are not missing essential information. An incomplete application will delay the review process.

HISTORIC REVIEW OF EXTERIOR ALTERATIONS SUBMITTAL CHECKLIST:

PLANNING APPLICATION FORM WITH AUTHORIZING SIGNATURES.

PROPERTY AND PROJECT INFORMATION.

Submit the following information (separately or on this page):

1. Historic District:

Monteith Hackleman Downtown Local Historic Commercial/Airport

2. Historic rating:

Historic Contributing Historic Non-Contributing Non-Historic (post 1945)

3. Year Built: 1889 Architectural Style(s): Queen Anne/Vernacular

4. Years of exterior alterations, if any: _____

5. Please describe the proposed alteration(s) and the purpose of the alterations: _____

Add 8.4kW Roof-mounted PV Solar array

PHOTOGRAPHS. Provide photographs that show the current condition of the area you intend to alter.

CONSTRUCTION PLANS/ELEVATION DRAWINGS. Provide construction plans, architectural drawings or schematics showing detailed building elevations and exterior plans, and dimensions of all altered or new elements, including foundation, windows, and the setbacks to the property lines, materials proposed, profile/design, etc. If construction plans or drawings are not applicable to your project, then submit an accurate alteration description, including photographs, or other information that describes the project.

cd.cityofalbany.net



Note: Some properties may have covenants or restrictions, which are private contracts between neighboring landowners. These frequently relate to density, minimum setbacks, or size and heights of structures. While these covenants and restrictions do not constitute a criterion for a City land use decision, they may raise a significant issue with regard to the City's land use criteria. It is the responsibility of the applicant to investigate private covenants or restrictions.

X REVIEW CRITERIA RESPONSES.

On a separate sheet of paper, prepare detailed written responses, using factual statements (called findings of fact), to explain how the historic exterior alteration complies with each of the following review criteria. Each criterion must have at least one finding of fact and conclusion statement. On a separate sheet of paper, prepare detailed written responses, using factual statements (called findings of fact), to explain how the historic exterior alteration complies with each of the following review criteria. Each criterion must have at least one finding of fact and conclusion statement. (See Example Findings of Fact starting on last page.)

1. The Community Development Director will approve **residential** alteration applications if one of the following criteria is met:
 - a. There is no change in historic character, appearance, or material composition from the existing structure.
 - b. The proposed alteration materially duplicates the affected exterior building features as determined from an early photograph, original building plans, or other evidence of original building features.
 - c. The proposed alteration is not visible from the street.
2. For all other exterior alteration requests, except for the use of substitute materials*, and including all **non-residential** requests, the review body must find that one of the following criteria has been met to approve an alteration request:
 - a. The proposed alteration will cause the structure to more closely approximate the historical character, appearance, or material composition of the original structure than the existing structure, or
 - b. The proposed alteration is compatible with the historic characteristics of the area and with the existing structure in massing, size, scale, materials, and architectural features.

**There is a different application for the use of substitute materials. The review criteria for the use of substitute siding, windows, and trim shall be as found in ADC Sections 7.170-7.225.*

The review body will use the Secretary of the Interior's Standards of Rehabilitation as guidelines in determining whether the proposed alteration meets the review criteria [ADC Section 7.160].

The Secretary of the Interior's Standards for Rehabilitation. The following standards are to be applied to rehabilitation projects in a reasonable manner, taking into consideration economic and technical feasibility.

1. A property shall be used for its historic purpose or be placed in a new use that requires minimal change to the defining characteristics of the building and its site and environment.
2. The historic character of a property shall be retained and preserved. The removal of historic material or alteration of features and spaces that characterize a property shall be avoided.
3. Each property shall be recognized as a physical record of its time, place, and use. Changes that create a false sense of historical development, such as adding conjectural features or architectural elements from other buildings, shall not be undertaken.
4. Most properties change over time; those changes that have acquired historic significance in their own right shall be retained and preserved.
5. Distinctive features, finishes, and construction techniques or examples of craftsmanship that characterize a historic property shall be preserved.

6. Deteriorated historic features shall be repaired rather than replaced. Where the severity of deterioration requires replacement of a distinctive feature, the new feature shall match the old in design, color, texture, and other visual qualities and, where possible, materials. Replacement of missing features shall be substantiated by documentary, physical, or pictorial evidence.
7. Chemical or physical treatments, such as sandblasting, that cause damage to historic material shall not be used. The surface cleaning of structures, if appropriate, shall be undertaken using the gentlest means possible.
8. Significant archeological resources affected by a project shall be protected and preserved. If such resources must be disturbed, mitigation measures shall be undertaken.
9. New additions, exterior alterations, or related new construction shall not destroy historic materials that characterize the property. The new work shall be differentiated from the old, and shall be compatible with the massing, size, scale, and architectural features to protect the historic integrity of the property and its environment.
10. New additions and adjacent or related new construction shall be undertaken in such a manner that if removed in the future, the essential form and integrity of the historic property and its environment would be unimpaired [ADC Section 7.160].

HISTORIC REVIEW OF EXTERIOR ALTERATIONS – PROCESS AND PROCEDURE

Purpose (ADC 7.100). The purpose of reviewing alterations to historic landmarks is to encourage the preservation of characteristics that led to their designation as historic landmarks. Review is required for exterior alterations or additions to buildings or structures classified as historic contributing and historic non-contributing within the historic districts, and to landmarks outside the districts.

Exemption from Review (ADC 7.110). Historic review is not required for buildings or structures originally constructed after 1945 or for changes to paint color to any home or structure.

Procedure (ADC 7.120). A request for an exterior alteration is reviewed and processed by either the Community Development Director or the Landmarks Commission. The Landmarks Commission replaces the Hearings Board or Planning Commission as the review body. Any exterior or interior alteration to buildings participating in Oregon’s Special Assessment of Historic Property Program will also require review and approval by the State Historic Preservation Office.

1. The Director will approve residential alteration requests if one of the following criteria is met:
 - a. There is no change in historic character, appearance, or material composition from the existing structure.
 - b. The proposed alteration materially duplicates the affected exterior building features as determined from an early photograph, original building plans, or other evidence of original building features.
 - c. The proposed alteration is not visible from the street.
2. For all other requests, the Landmarks Commission will review and process the alteration proposal. The applicant and adjoining property owners within 100 feet will receive notification of the Landmarks Commission public hearing on the proposal. The Landmarks Commission will accept written and verbal testimony on the proposal. For buildings on the Special Assessment of Historic Property Program, the Landmarks Commission decision will be forwarded to the State Historic Preservation Office.

EXAMPLE OF FINDINGS OF FACT

Criteria for Findings of Fact

Land use applications must include information that explains the intent, nature, and proposed use of the development, and other pertinent information that may have bearing on the action to be taken by the review authority. To be approved, a Historic Review application must address and demonstrate compliance with the

applicable review criteria in Article 7 and related requirements. If the applicant's submittal is unclear or insufficient to demonstrate the review criteria are satisfied, the application will be delayed or denied.

Format for Findings of Fact

Statements addressing individual criteria must be in a "finding of fact" format. A finding of fact consists of two parts:

1. Factual information such as the distance between buildings, the width and type of streets, the particular operating characteristics of a proposed use, etc. Facts should reference their source: on-site inspection, a plot plan, City plans, etc.
2. An explanation of how those facts result in a conclusion supporting the criterion.

Example:

Criterion: The proposed alteration will cause the structure to more closely approximate the historical character, appearance, or material composition of the original structure than the existing structure.

Facts: The Cultural Resource Inventory indicates that the house was constructed c.1885 and the style is a Western Farmhouse. The decorative features noted are rectangular bays on the north and east sides with panels, turned porch columns and a fixed window with a diamond shaped pattern on the east side. Sanborn Fire map research indicates that the porch originally extended the full length of the west wing of the house.

This application proposes to restore the front porch to the full length of the west wing of the house. Additional porch columns are proposed to match the existing turned porch columns; a hipped roof is proposed consistent with existing entry and bays and Sanborn maps. The current porch, which now only covers the front door, is more of a covered entry than a porch. The balusters are a connected "sawn" design (rather than turned) that was typical in the late 19th century. (SEE ATTACHED DRAWING.)

Conclusion: Extending the porch to its original size will cause the structure to more closely approximate its historic character and appearance.

To whom it may concern in regards to the Historic District of Albany,

In regards to the tentative solar installation at 538 SW 4th Ave, Albany, OR 97322, We propose the 8.4kW solar system as pictured below. The solar system we propose is a temporary solution to solar's future availability of solar shingles. This is a temporary addition to the home to eliminate most of the customers electric bill to help improve the environment until solar shingles are made more available and more feasible. At the time of the availability of solar shingles the existing solar panels can be reused and recycled on a non historic district home or ground mount at another location. This is a temporary addition to the home that will not alter the historic home's appearance permanently. The Department of Energy Exclaims, "Solar energy can also improve air quality, reduce water use from energy production, and provide ecosystem services for host communities through carbon sequestration, pollination, and ground and stormwater management."

Criterion: There is no change in historic character, appearance, or material composition from the existing structure.

Facts: As we designed the solar system with the homeowner we experimented with all roof plains, with the compromise production we selected an array that occupies all the roofs that can not be seen from the road. Any part of the array that can be minimally seen from the road is very challenging due to the steep angles, degree of the roof, roof pitch, distance of vision, and sight of line.

Conclusion: Adding solar to non visible roof plains that don't face the street will cause the structure to more closely approximate its historic character and appearance, and will help the environment in doing so.

Criterion: The proposed alteration materially duplicates the affected exterior building features as determined from an early photograph, original building plans, or other evidence of original building features.

Facts: The proposed alteration is temporary until the more inconspicuous solar shingles become more available and feasible to install. The solar installation is temporary and does not affect the structural integrity of the building that sits below.

Conclusion: The proposed alteration is temporary and does not alternate the original exterior building features.

Criterion: The proposed alteration is not visible from the street.

Facts: As we designed the solar system with the homeowner we experimented with all roof plains, with the compromise production we selected an array that occupies all the roofs that can not be seen from the road. Any part of the array that can be minimally seen from the road is very challenging due to the steep angles, degree of the roof, roof pitch, distance of vision, and sight of line.

Conclusion: Adding solar to non visible roof plains that don't face the street will cause the structure to more closely approximate its historic character and appearance, and will help the environment in doing so.



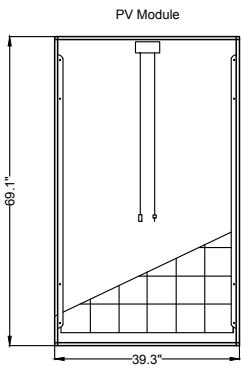

4 Module Details
S2 Front View NTS

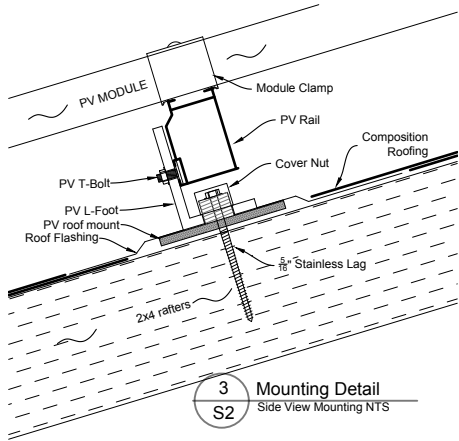

3 Mounting Detail
S2 Side View Mounting NTS

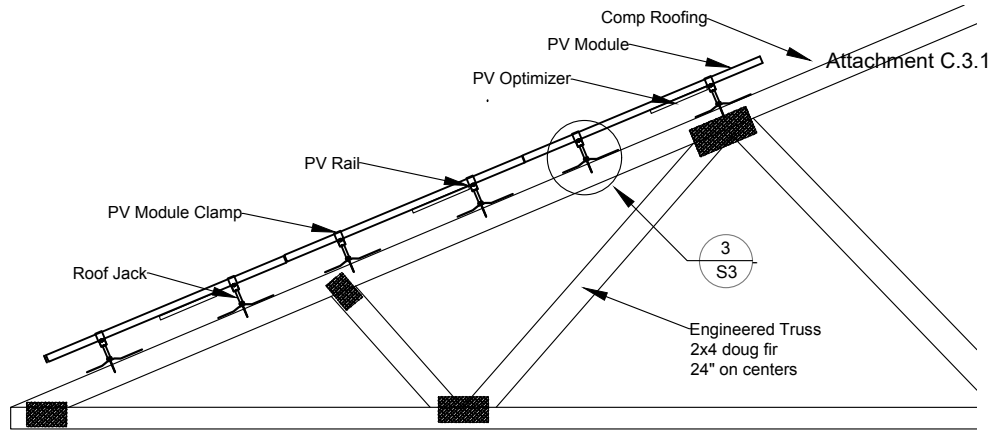

2 Roof Plan Typical
S2 Side View Mounting NTS

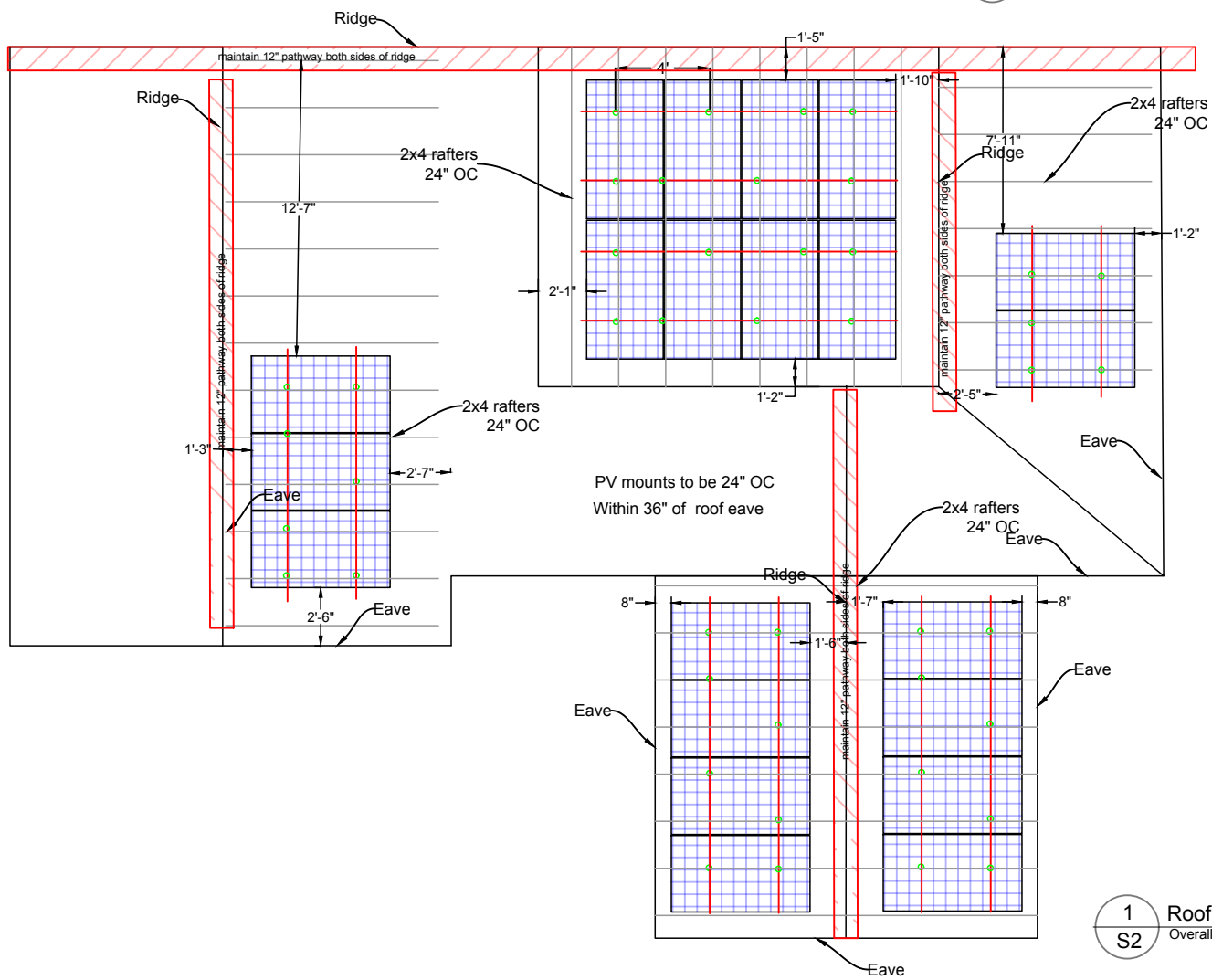

1 Roof Layout
S2 Overall Layout NTS

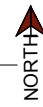

PURE ENERGY GROUP, INC
 139 ANKENY HILL RD SE, JEFFERSON, OR 97352
 CCB# 235232 EXP. 03/23 BCD #C1653 EXP. 07/23
 ELECTRICAL SUPERVISOR NOEL LETSON #66175
 TRAVIS SHEFFIELD MOBILE 541-936-0980
 INFO@PUREENERGY.GROUP WWW.PUREENERGY.GROUP

Hans Solar
 538 4th AVE SW
 Albany, OR 97321

DATE 11/15/2023
 DRAFTER TSS
 REVISION Permit Set
 FILE I:\users\travis\Library\CloudStorage\GoogleDrive\travis@pureenergy.group\Shared\drives\PEG Master Drive\2024 Projects\Hans\Hans.dwg

SHEET
S2
 18



PURE ENERGY GROUP, INC
139 ANKENY HILL RD SE, JEFFERSON, OR 97352
CCB# 235232 Exp. 03/23 BCD #C1653 Exp. 07/23
ELECTRICAL SUPERVISOR NOEL LETSON #66175
TRAVIS SHEFFIELD MOBILE 541-936-0980
INFO@PUREENERGY.GROUP WWW.PUREENERGY.GROUP

Hans Solar
538 4th AVE SW
Albany, OR 97321

DATE 11/15/2023
DRAFTER TSS
REVISION Permit Set
FILE \\userstravel\Library\Cad\Drawings\Code\Drawings\@pureenergy.group\Shared\drive\PEG Master Drive\2024 Projects\Hans\Hans.dwg

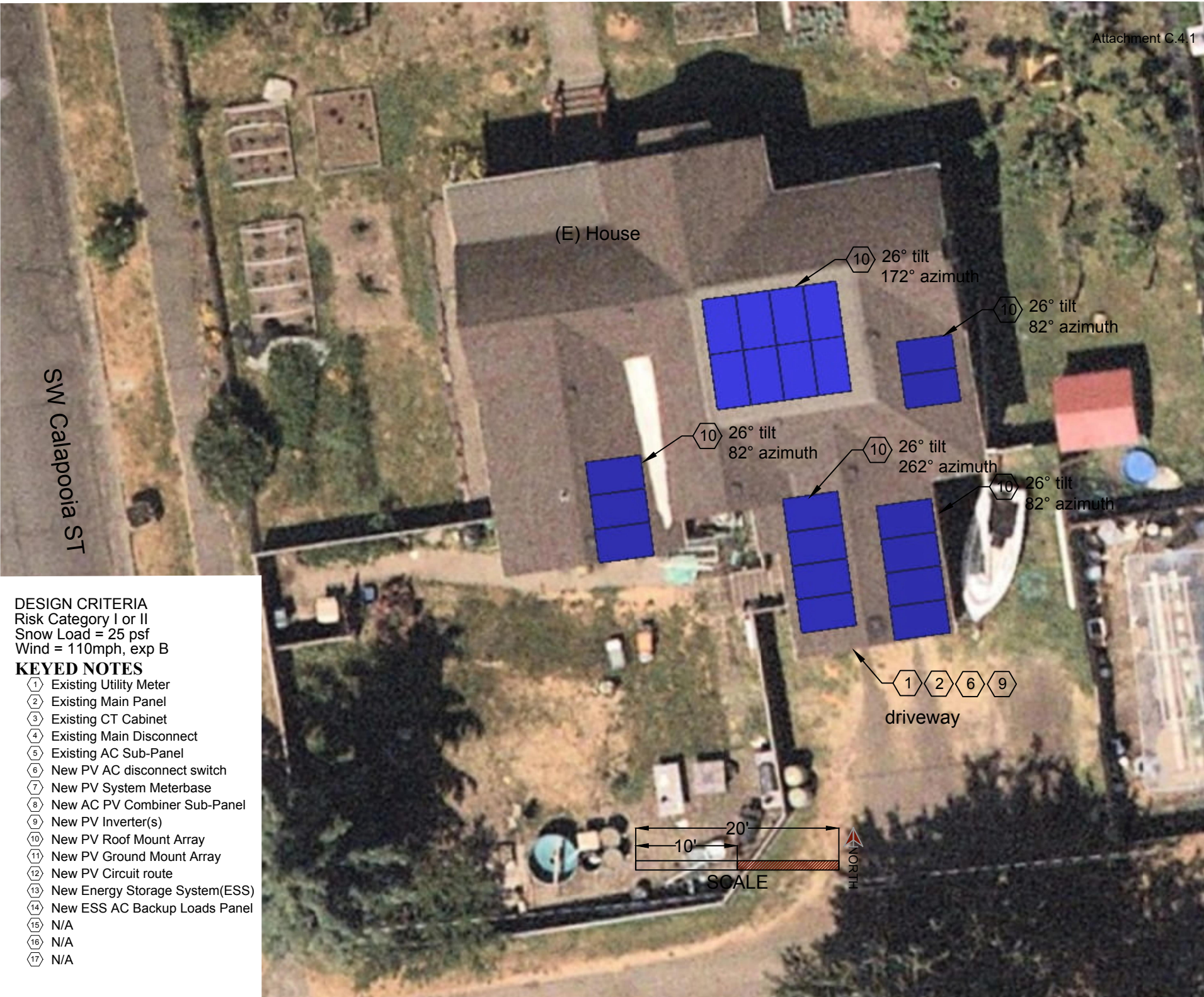

DESIGN CRITERIA
Risk Category I or II
Snow Load = 25 psf
Wind = 110mph, exp B

KEYED NOTES

- ① Existing Utility Meter
- ② Existing Main Panel
- ③ Existing CT Cabinet
- ④ Existing Main Disconnect
- ⑤ Existing AC Sub-Panel
- ⑥ New PV AC disconnect switch
- ⑦ New PV System Meterbase
- ⑧ New AC PV Combiner Sub-Panel
- ⑨ New PV Inverter(s)
- ⑩ New PV Roof Mount Array
- ⑪ New PV Ground Mount Array
- ⑫ New PV Circuit route
- ⑬ New Energy Storage System(ESS)
- ⑭ New ESS AC Backup Loads Panel
- ⑮ N/A
- ⑯ N/A
- ⑰ N/A

The SMR System represents a huge leap in racking technology. Optimized design makes the SMR Rails not only the lightest but also the strongest rails on the market. One tool assembly and Pop-On technology allow fast and worry-free installation. The cost and performance cannot be beaten.

SMR100 Rail

4' span or more up to 60 psf snow load or 190 mph winds



SMR200 Rail

4' span or more up to 90 psf snow load or 190 mph winds

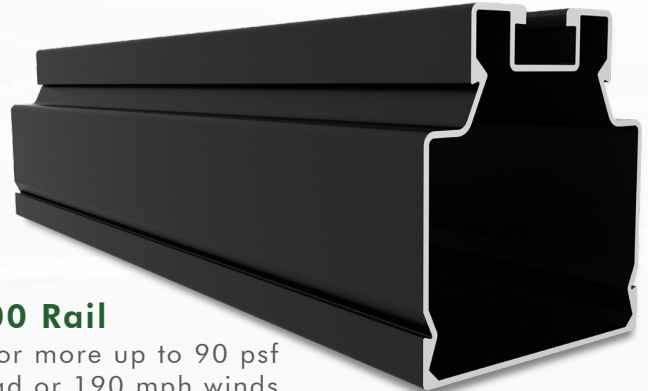

Clamps & Grounding



Mid Clamp

The Bonding Pop-On Universal Mid Clamps accommodate PV module frame heights ranging from 30mm to 50mm. The fastest installing Mid Clamps on the market.

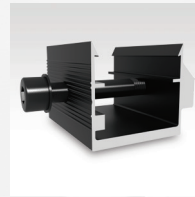

L Foot Adaptor

Fast and easy Pop-On L-Foot Adaptor speeds installation and eliminates old-fashioned T-Bolts. Install fast with full confidence in every attachment.



End Clamp

End Clamps are adjustable for different module frame heights and provide fast and secure attachment of modules.



Rail Splice

Fully structural bonding splice with fast and easy single bolt installation



Shared Rail Mid/End Clamp

Easily adapt racking to Shared Rail install. Uses the same Pop-On technology to provide fast and easy install.

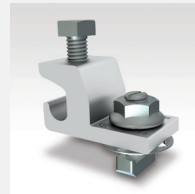

Grounding Lug

The Lug provides proper grounding of the PV System

Technical Data

Application	Pitched Roof
Roof Type	Composition shingle, Metal and Tile
Material	High grade aluminum and 304 stainless steel hardware
PV Modules	Compatible with all common module types
Module Orientation	Portrait and landscape
Roof Attachment	Rafter and decking
Structural Integrity	IBC compliant, stamped engineering letters available
Certificate	UL 2703 listed by ETL
Warranty	25 years

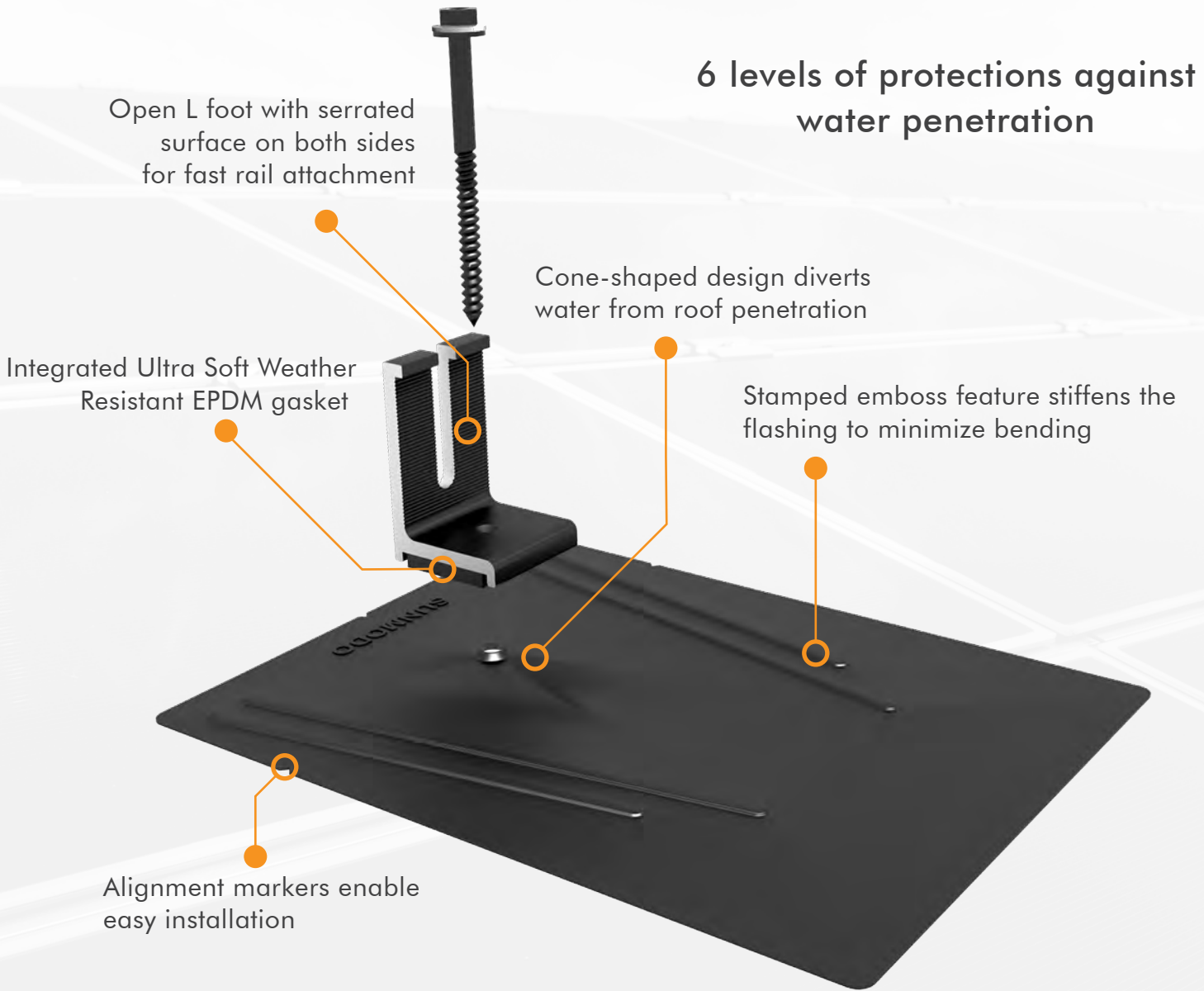

6 levels of protections against water penetration

Open L foot with serrated surface on both sides for fast rail attachment

Cone-shaped design diverts water from roof penetration

Integrated Ultra Soft Weather Resistant EPDM gasket

Stamped emboss feature stiffens the flashing to minimize bending

Alignment markers enable easy installation

Technical Data

Application	Composite shingle
Material	High grade aluminum, 304 stainless steel hardware
Finish	Silver or black powder coating
Flashing Size	9 x 12 inch
Roof Attachment	Rafter only
Structural integrity	IBC and IRC Compliant
Warranty	25 years

Single Phase Inverter with HD-Wave Technology

for North America

SE3000H-US / SE3800H-US / SE5000H-US / SE6000H-US /
SE7600H-US / SE10000H-US / SE11400H-US



Optimized installation with HD-Wave technology

- / Specifically designed to work with power optimizers
- / Record-breaking 99% weighted efficiency
- / Quick and easy inverter commissioning directly from a smartphone using the SolarEdge SetApp
- / Fixed voltage inverter for longer strings
- / Integrated arc fault protection and rapid shutdown for NEC 2014, NEC 2017 and NEC 2020 per article 690.11 and 690.12
- / UL1741 SA certified, for CPUC Rule 21 grid compliance
- / Small, lightweight, and easy to install both outdoors or indoors
- / Built-in module-level monitoring
- / Optional: Faster installations with built-in consumption metering (1% accuracy) and production revenue grade metering (0.5% accuracy, ANSI C12.20)

/ Single Phase Inverter with HD-Wave Technology

for North America

SE3000H-US / SE3800H-US / SE5000H-US / SE6000H-US/
SE7600H-US / SE10000H-US / SE11400H-US

MODEL NUMBER	SE3000H-US	SE3800H-US	SE5000H-US	SE6000H-US	SE7600H-US	SE10000H-US	SE11400H-US	
APPLICABLE TO INVERTERS WITH PART NUMBER	SEXXXXH-XXXXXBXX4							
OUTPUT								
Rated AC Power Output	3000	3800 @ 240V 3300 @ 208V	5000	6000 @ 240V 5000 @ 208V	7600	10000	11400 @ 240V 10000 @ 208V	VA
Maximum AC Power Output	3000	3800 @ 240V 3300 @ 208V	5000	6000 @ 240V 5000 @ 208V	7600	10000	11400 @ 240V 10000 @ 208V	VA
AC Output Voltage Min.-Nom.-Max. (211 - 240 - 264)	✓	✓	✓	✓	✓	✓	✓	Vac
AC Output Voltage Min.-Nom.-Max. (183 - 208 - 229)	-	✓	-	✓	-	-	✓	Vac
AC Frequency (Nominal)	59.3 - 60 - 60.5 ⁽¹⁾							Hz
Maximum Continuous Output Current @240V	12.5	16	21	25	32	42	47.5	A
Maximum Continuous Output Current @208V	-	16	-	24	-	-	48.5	A
Power Factor	1, Adjustable - 0.85 to 0.85							
GFDI Threshold	1							A
Utility Monitoring, Islanding Protection, Country Configurable Thresholds	Yes							
INPUT								
Maximum DC Power @240V	4650	5900	7750	9300	11800	15500	17650	W
Maximum DC Power @208V	-	5100	-	7750	-	-	15500	W
Transformer-less, Ungrounded	Yes							
Maximum Input Voltage	480							Vdc
Nominal DC Input Voltage	380			400				Vdc
Maximum Input Current @240V ⁽²⁾	8.5	10.5	13.5	16.5	20	27	30.5	Adc
Maximum Input Current @208V ⁽²⁾	-	9	-	13.5	-	-	27	Adc
Max. Input Short Circuit Current	45							Adc
Reverse-Polarity Protection	Yes							
Ground-Fault Isolation Detection	600k Ω Sensitivity							
Maximum Inverter Efficiency	99	99.2						%
CEC Weighted Efficiency	99						99 @ 240V 98.5 @ 208V	%
Nighttime Power Consumption	< 2.5							W

(1) For other regional settings please contact SolarEdge support

(2) A higher current source may be used; the inverter will limit its input current to the values stated

/ Single Phase Inverter with HD-Wave Technology for North America

SE3000H-US / SE3800H-US / SE5000H-US / SE6000H-US/
SE7600H-US / SE10000H-US / SE11400H-US

MODEL NUMBER	SE3000H-US	SE3800H-US	SE5000H-US	SE6000H-US	SE7600H-US	SE10000H-US	SE11400H-US	
ADDITIONAL FEATURES								
Supported Communication Interfaces	RS485, Ethernet, ZigBee (optional), Cellular (optional)							
Revenue Grade Metering, ANSI C12.20	Optional ⁽³⁾							
Consumption metering								
Inverter Commissioning	With the SetApp mobile application using Built-in Wi-Fi Access Point for Local Connection							
Rapid Shutdown - NEC 2014, NEC 2017 and NEC 2020, 690.12	Automatic Rapid Shutdown upon AC Grid Disconnect							
STANDARD COMPLIANCE								
Safety	UL1741, UL1741 SA, UL1699B, CSA C22.2, Canadian AFCI according to T.I.L. M-07							
Grid Connection Standards	IEEE1547, Rule 21, Rule 14 (HI)							
Emissions	FCC Part 15 Class B							
INSTALLATION SPECIFICATIONS								
AC Output Conduit Size / AWG Range	1" Maximum / 14-6 AWG				1" Maximum /14-4 AWG			
DC Input Conduit Size / # of Strings / AWG Range	1" Maximum / 1-2 strings / 14-6 AWG				1" Maximum / 1-3 strings / 14-6 AWG			
Dimensions with Safety Switch (HxWxD)	17.7 x 14.6 x 6.8 / 450 x 370 x 174				21.3 x 14.6 x 7.3 / 540 x 370 x 185			
Weight with Safety Switch	22 / 10	25.1 / 11.4	26.2 / 11.9	38.8 / 17.6			lb / kg	
Noise	< 25				<50			dBA
Cooling	Natural Convection							
Operating Temperature Range	-40 to +140 / -40 to +60 ⁽⁴⁾							°F / °C
Protection Rating	NEMA 4X (Inverter with Safety Switch)							

(3) Inverter with Revenue Grade Meter P/N: SExxxH-US000BNC4; Inverter with Revenue Grade Production and Consumption Meter P/N: SExxxH-US000BNI4 . For consumption metering, current transformers should be ordered separately: SEACT0750-200NA-20 or SEACT0750-400NA-20. 20 units per box

(4) Full power up to at least 50°C / 122°F; for power de-rating information refer to: <https://www.solaredge.com/sites/default/files/se-temperature-derating-note-na.pdf>

How to Enable Consumption Monitoring

By simply wiring current transformers through the inverter's existing AC conduits and connecting them to the service panel, homeowners will gain full insight into their household energy usage helping them to avoid high electricity bills

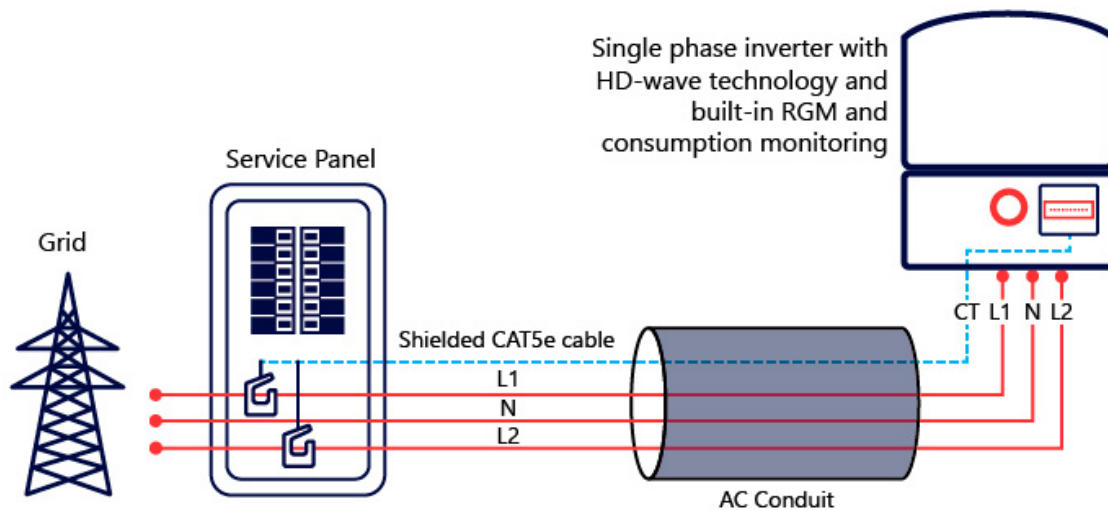

SILFAB PRIME

SIL-400 HC+

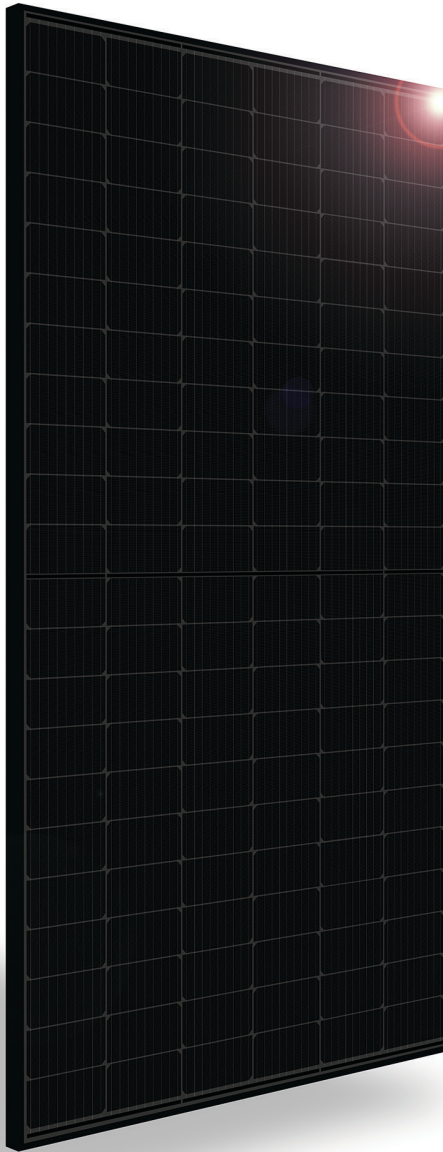

RELIABLE ENERGY. DIRECT FROM THE SOURCE.

Designed to outperform.

Dependable, durable, high-performance solar panels engineered for North American homeowners.

SILFABSOLAR.COM



CHUBB®

* Chubb provides error and omission insurance to Silfab Solar Inc.

ELECTRICAL SPECIFICATIONS		400	
Test Conditions		STC	NOCT
Module Power (Pmax)	Wp	400	298
Maximum power voltage (Vpmax)	V	36.05	33.50
Maximum power current (Ipmax)	A	11.10	8.90
Open circuit voltage (Voc)	V	43.02	40.35
Short circuit current (Isc)	A	11.58	9.34
Module efficiency	%	20.2%	18.8%
Maximum system voltage (VDC)	V		1000
Series fuse rating	A		20
Power Tolerance	Wp		0 to +10

Measurement conditions: STC 1000 W/m² • AM 1.5 • Temperature 25 °C • NOCT 800 W/m² • AM 1.5 • Measurement uncertainty ≤ 3%
 Sun simulator calibration reference modules from Fraunhofer Institute. Electrical characteristics may vary by ±5% and power by 0 to +10W.

MECHANICAL PROPERTIES / COMPONENTS	METRIC	IMPERIAL
Module weight	21.3kg ±0.2kg	47lbs ±0.4lbs
Dimensions (H x L x D)	1914 mm x 1036 mm x 35 mm	75.3 in x 40.8 in x 1.37 in
Maximum surface load (wind/snow)*	5400 Pa rear load / 5400 Pa front load	112.8 lb/ft ² rear load / 112.8 lb/ft ² front load
Hail impact resistance	ø 25 mm at 83 km/h	ø 1 in at 51.6 mph
Cells	132 Half cells - Si mono PERC 9 busbar - 83 x 166 mm	132 Half cells - Si mono PERC 9 busbar - 3.26 x 6.53 in
Glass	3.2 mm high transmittance, tempered, DSM antireflective coating	0.126 in high transmittance, tempered, DSM antireflective coating
Cables and connectors (refer to installation manual)	1350 mm, ø 5.7 mm, MC4 from Staubli	53 in, ø 0.22 in (12AWG), MC4 from Staubli
Backsheet	High durability, superior hydrolysis and UV resistance, multi-layer dielectric film, fluorine-free PV backsheet	
Frame	Anodized Aluminum (Black)	
Bypass diodes	3 diodes-30SQ045T (45V max DC blocking voltage, 30A max forward rectified current)	
Junction Box	UL 3730 Certified, IEC 62790 Certified, IP68 rated	

TEMPERATURE RATINGS		WARRANTIES	
Temperature Coefficient Isc	+0.064 %/°C	Module product workmanship warranty	25 years**
Temperature Coefficient Voc	-0.28 %/°C	Linear power performance guarantee	30 years
Temperature Coefficient Pmax	-0.36 %/°C		≥ 97.1% end 1st yr ≥ 91.6% end 12th yr ≥ 85.1% end 25th yr ≥ 82.6% end 30th yr
NOCT (± 2°C)	45 °C		
Operating temperature	-40/+85 °C		

CERTIFICATIONS		SHIPPING SPECS	
Product	UL 61215-1:2017 Ed.1, UL 61215-2:2017 Ed.1, UL 61730-1:2017 Ed.1, UL 61730-2:2017 Ed.1, CSA C22.2#61730-1:2019 Ed.2, CSA C22.2#61730-2:2019 Ed.2, IEC 61215-1:2016 Ed.1, IEC 61215-2:2016 Ed.1, IEC 61730-1:2016 Ed.2, IEC 61730-2:2016 Ed.2, IEC 61701:2020 (Salt Mist Corrosion), IEC 62716:2013 (Ammonia Corrosion), UL Fire Rating: Type 2, CEC Listed.	Modules Per Pallet:	26 or 26 (California)
Factory	ISO9001:2015	Pallets Per Truck	32 or 30 (California)
		Modules Per Truck	832 or 780 (California)

* ⚠ Warning. Read the Safety and Installation Manual for mounting specifications and before handling, installing and operating modules.
 ** 12 year extendable to 25 years subject to registration and conditions outlined under "Warranty" at silfabsolar.com.
 PAN files generated from 3rd party performance data are available for download at: silfabsolar.com/downloads.

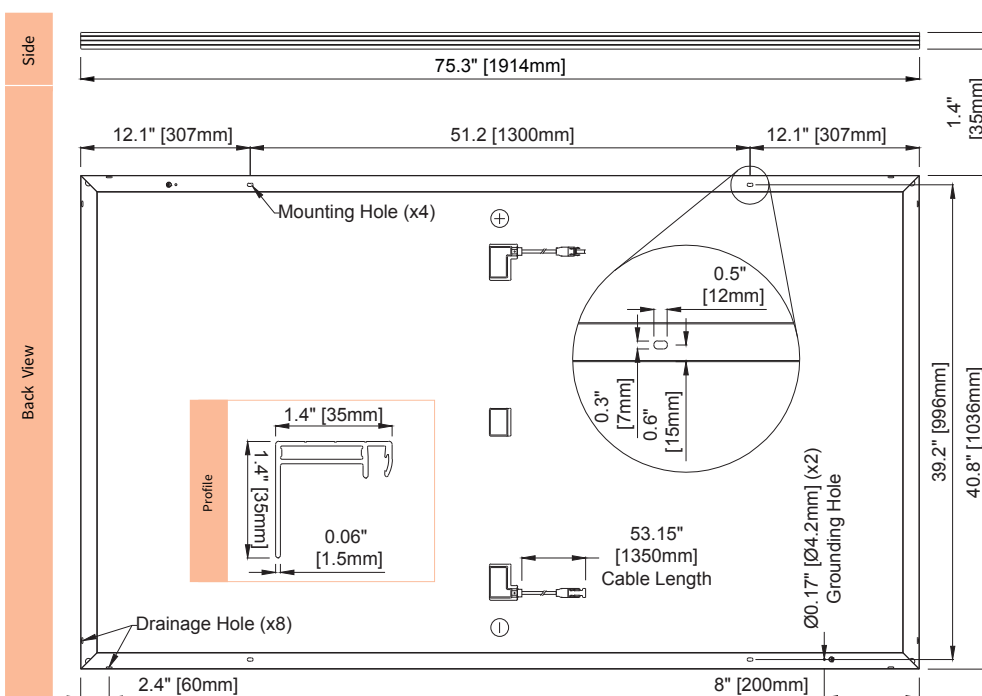

SILFAB SOLAR INC.

800 Cornwall Ave
 Bellingham WA 98225 USA
 T +1 360.569.4733
 info@silfabsolar.com
 SILFABSOLAR.COM

1770 Port Drive
 Burlington WA 98233 USA
 T +1 360.569.4733

240 Courtneypark Drive East
 Mississauga ON L5T 2Y3 Canada
 T +1 905.255.2501
 F +1 905.696.0267

Silfab - SIL-400-HC+-20230726
 No reproduction of any kind is allowed without permission. Data and information is subject to modifications without notice. © Silfab Solar Inc., 2022. Silfab Solar® is a registered trademark of Silfab Solar Inc.